

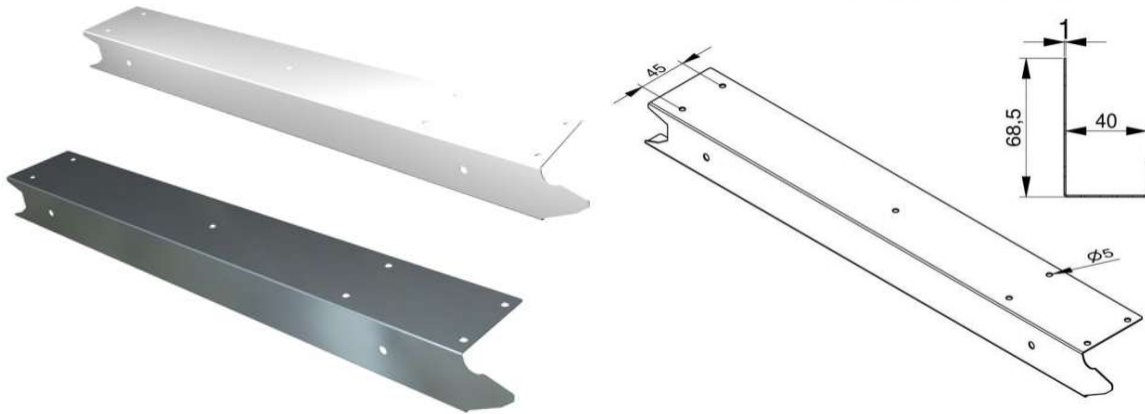

END CAP FOR PANEL EPCO, H=555MM, RIGHT
ARTICLE: 217081



Factory price: 2.50 € (excl. VAT) / piece Price without VAT

PRODUCT DESCRIPTION

End cap for sectional door panel EPCO
Material: Galvanised steel
Panel EPCO H=555mm with finger safe edge
Right

ADDITIONAL INFORMATION

Weight	0.43 kg
Producent	D
Materiał	Steel
Zastosowanie	sectional door
Shipping class	Standard

